



PALLET APPLICATION GUIDE

Pallet multi-functional display furniture inspires collaboration for the open office environment. Designed for today's mobile, configurable, and collaborative needs; Pallet can stand alone, be used for impromptu workstations, or to divide spaces. This Application Guide unveils the possibilities for how Pallet can be utilized within your space. Take a peek inside and build your own case by choosing the finishes, laminates, and accessories through our item number generator and pricer, while learning about Pallet's specifications and limited lifetime warranty.

REDEFINING SPACE DIVISION



In this photo: Double-sided Pallet Poplar Java with White Credenza and Metal Door Pulls.

HOW TO USE



Rethink Space Division

Pallet was designed specifically for open offices in need of space division while maintaining the ability to filter light and allow the space to still feel open and airy. Pallet can be used as a wall by placing multiple units side-by-side to showcase a clean way to divide separate work areas.

Expand Workstations

Impromptu meetings happen every day, especially in open offices. When off-site employees or even clients and customers are in the office, simply use Pallet with a desk for them to work or brainstorm with others. Outfit Pallet with accessories, including the whiteboard and marker/eraser holder, to create a workstation and area to store their belongings when needed.



Create Collaborative Huddle Zones

Add functionality and a design element for space division between collaboration and impromptu brainstorming areas with Pallet. Divide the space with a single or double-sided unit and use the whiteboard accessory for brainstorming.



Enhance Conference Rooms & Private Offices

Pallet's single-sided unit can be used against a wall in any location to bring the residential feel into your environment. Conference rooms, for example, can be stuffy and sometimes boring; using Pallet allows you to personalize the space by staging it to reflect your brand or design aesthetics.



Enhance Conference Rooms & Private Offices



Personalize Lobbies & Reception Areas

Reception areas and lobbies are designed to make guests feel at home. Pallet was made to complement any décor while allowing personalization to occur. Promote the brand and company interests, awards, and style to set the tone for your customers and guests as they walk through the door.



Standards



Pallet was designed to meet and/or exceed standards set by BIFMA, including BIFMA tip-testing standard X5.9-2012.

Frame - Slated Wall

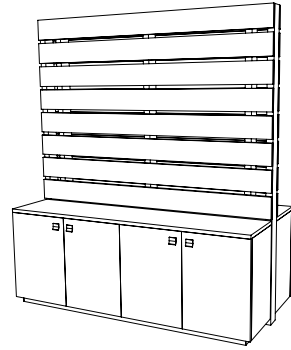

- Solid wood slats are 5-1/8" high. Each Pallet features eight slats per side when combined with a credenza and 12 slats on the back of a single-sided Pallet.
- There is 7/8" spacing between each slat.
- Each frame includes a 1-1/2" high recessed wooden toe kick.
- Three internal wooden support stiles for 63" wide unit: two stiles for 38" unit for structural strength.
- Design allows for multiple units to be ganged together side-by-side.

Storage Credenza



- The 63" wide Pallet features a 23" high x 63" wide x 14" deep credenza with four non-locking, euro-styled hinged doors and two adjustable height shelves.
- The 38" wide Pallet features a 23" high x 38" wide x 14" deep credenza with two non-locking, euro-styled hinged doors and one adjustable-height shelf.

Shelving

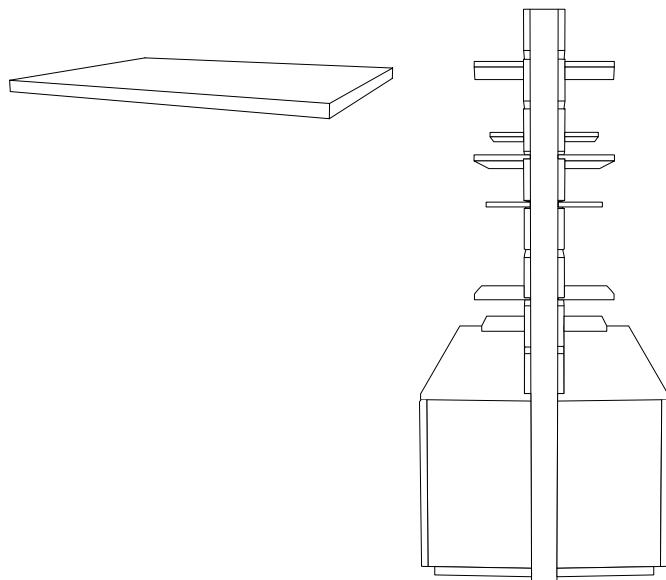

- Pallet offers two sizes of insertable HPL-clad shelves that can be positioned through the front and back of the double-sided unit, or only on the front of the case when using as a single-sided unit.
- The Large Shelf is 3/4" high x 24" wide x 17-1/2" deep.
- The Small Shelf is 3/4" high x 12" wide x 17-1/2" deep.
- The shelves can be positioned to work either single or double-sided and come with grip tape for additional slide-resistance.
- The 63" wide Pallet comes with six shelves: two large and four small.
- The 38" wide unit comes with three shelves: one large and two small.
- Weight capacity per shelf is 25 lbs.

Finishes

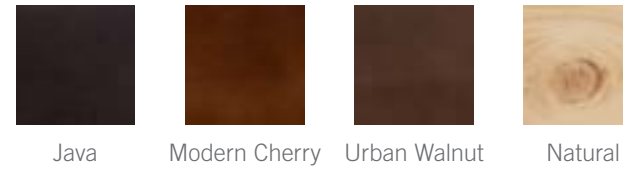

- Poplar wood available in Java, Modern Cherry, and Urban Walnut. Knotty Pine wood available in Modern Cherry, Urban Walnut, and Natural finishes.
- Stain matching and custom stains are also available. Call 1.800.622.1331 for more information.
- Waddell uses custom-tailored water-based stains to honor the character of the wood, and is environmentally friendly.
- After the four-step staining process, a generous clear coat of Hydro-Gold® Clear is applied to ensure the stain lasts a lifetime.

Laminates

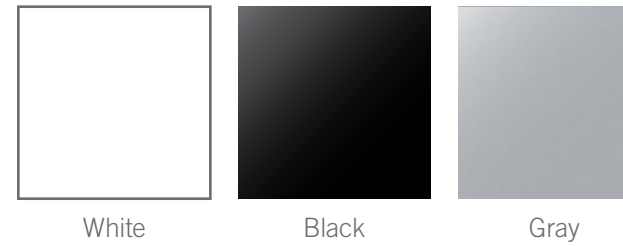

- Standard laminate colors for shelving and credenza: White, Black, and Gray.
- The shelves and storage credenza for Pallet use a matte-finish HPL laminate that resists fingerprints and bacterial growth.
- When choosing a laminate, the laminate for the shelving and credenza will match. Mixing of laminates for shelves and credenzas is also available.
- Custom laminates also available.

Floor Levelers

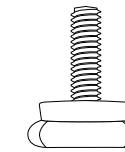

- Four threaded, adjustable, metal levelers are included with each Pallet.
- Four floor levelers are positioned in each corner of the display, lift or lower each individually to level the unit.

Electric

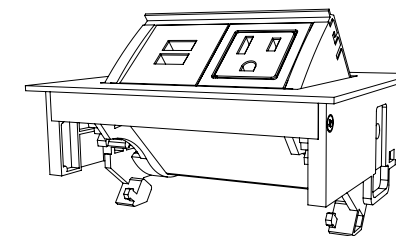

- Pre-wired power located on the storage credenza.
- The electrical box will match the color of the laminate chosen for the storage credenza: White, Black, or Gray.
- The electrical unit features two USB ports and one 120V outlet and has a 10' cord. Electric is UL approved.
- Double-sided units receive two electrical outlets, one on each side of storage credenza while single-sided units receive one.

Packing Info



- Ships fully assembled, secured to a shipping skid, and protected by clear stretch wrap.

BUILD YOUR PALLET

Use this section to build your Pallet with options and accessories. Each step will help you determine your Pallet product number. Item number options are listed in blue text.

1 Choose Your Style & Size

ID	DOUBLE-SIDED
PLT1	72" H x 63" W x 32" D
PLT3	72" H x 38" W x 32" D

ID	SINGLE-SIDED
PLT2	72" H x 63" W x 19" D
PLT4	72" H x 38" W x 19" D



2 Choose Your Wood Species

ID	POPLAR			
	Double-Sided	List \$	Single-Sided	List \$
PO	63"	\$7,200	63"	\$6,000
PO	38"	\$5,600	38"	\$4,500

ID	KNOTTY PINE			
	Double-Sided	List \$	Single-Sided	List \$
PN	63"	\$6,400	63"	\$5,400
PN	38"	\$4,800	38"	\$3,900



Poplar wood has a refined and elegant appearance.



Knotty Pine wood highlights the raw beauty of the wood, giving a rustic appeal.

3 Choose Your Wood Finish

FINISH			
ID	POPLAR	ID	KNOTTY PINE
U	Urban Walnut	U	Urban Walnut
M	Modern Cherry	M	Modern Cherry
J	Java	N	Natural



Urban Walnut, Modern Cherry, Java, and Natural finishes are available for Poplar wood. Urban Walnut, Modern Cherry, and Natural finishes are available for Knotty Pine wood.

Poplar wood available in Java, Modern Cherry, and Urban Walnut. Knotty Pine wood available in Modern Cherry, Urban Walnut, and Natural.

Custom stains and stain matching are available. Call 1.800.622.1331 for more information.

4 Choose Your Laminate for Credenza & Shelving

ID	COLOR
WHT	White
BLK	Black
GRY	Gray

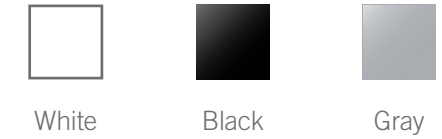

Double-sided units include two large and four small shelves, while the single-sided unit includes one large, and two small shelves.

Custom laminates are available. Call 1.800.622.1331 for more information.

5 Choose Your Door Pull

ID	PULL TYPE
M	Nickel Metal
L	Leather Pull
N	No Pull*



Nickel

Leather

*Choose No Pull when supplying your own to complement your current environment. No Pulls will be shipped, no holes will be drilled.

6 Electric

ID	Electric Options			
	Double-Sided	List \$	Single-Sided	List \$
E	Electric*	\$1,600	Electric	\$800
	No Electric		No Electric	



Electric

*Electric box color will match the color of laminate: White laminate would include a white coated electric box. If no electric is chosen, do not add anything to part number.

BUILD YOUR PRODUCT NUMBER

Using the example below, write in your custom product number based on the product options you chose.

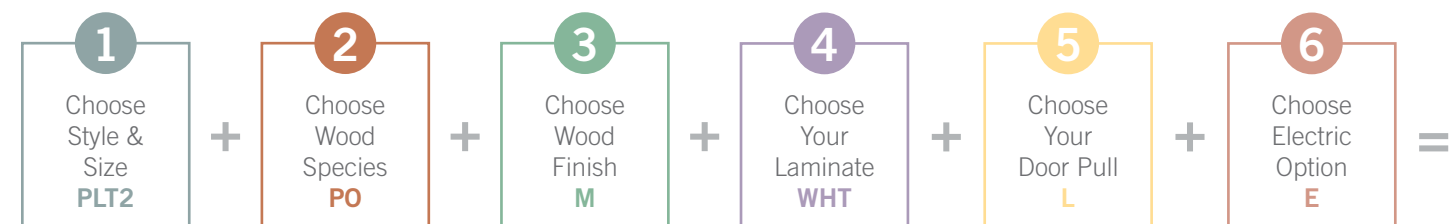

EXAMPLE

PLT2 **PO** **M** **WHT** **L** **E**

Style and Size Species Finish Laminate Door Pull Electric



ACCESSORIES

Once you have built your Pallet display furniture, add personality with Pallet accessories. To order, add the accessory item numbers to your order. Each accessory is ordered separately.

PLT-WHITEBD – Magnetic Whiteboard – \$250.00 LIST

For the ultimate workstation or brainstorming session, the Pallet Whiteboard utilizes a cantilever* that allows the board to hang within the slats. The Whiteboard is inherently magnetic and is shipped with one magnetic eraser and four magnetic markers.

NOTE: The whiteboard is 24" H x 23" W.

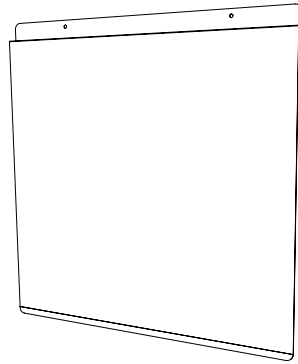

PLT-CUBBY – Pallet Cubby – \$95.00 LIST

Pallet Cubby is an accessory holder, perfect for holding markers and erasers when the magnetic whiteboard is in use. It can also be used as a planter to bring nature into your environment. The Pallet Cubby is an ABS plastic container that is magnetized to our powder-coated steel cantilever* base plate.

NOTE: Pallet Cubby can hold up to 3 lbs.

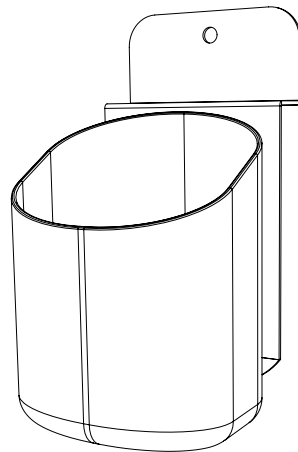

PLT-ARCHIVE – Pallet Archive – \$185.00 LIST

Pallet Archive is an accessory holder for magazines, books, or other materials when using Pallet as a workstation or huddle area for brainstorming. The Pallet Archive is an ABS plastic container that is magnetized to our powder-coated steel cantilever* base plate.

NOTE: Pallet Archive can hold up to 10 lbs.

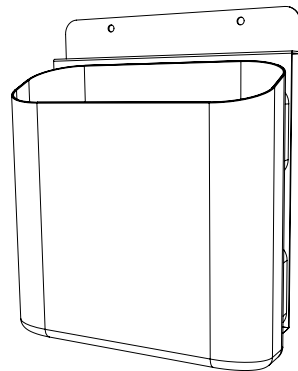

PLT-VALET – Pallet Valet – \$155.00 LIST

Pallet Valet is an accessory holder for personal items when used as a workstation or huddle center, and can also hold branded materials promoting company initiatives. The Pallet Valet is an ABS plastic container that is magnetized to our powder-coated steel cantilever* base plate.

NOTE: Pallet Valet can hold up to 5 lbs.

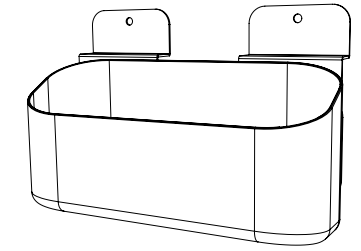

PLT-HOOK – Accessory Hooks – \$50.00 LIST

Our aluminum extruded cantilever* hook will allow users to hang coats, hats, umbrellas, or other personal items to help keep your environment clutter-free.

NOTE: Includes two Accessory Hooks that can hold 25 lbs. each

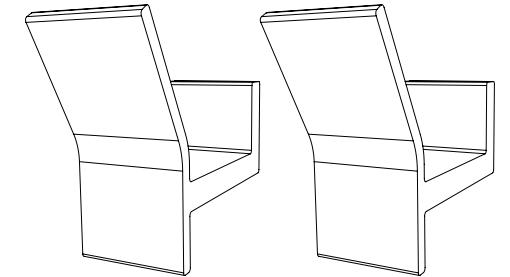

PLT-LGSHELF-BLK PLT-LGSHELF-GRY PLT-LGSHELF-WHT

Additional Shelving Sets: Large Shelves – \$400 LIST

Includes two large shelves that are available in three different laminates: White, Gray, and Black.

NOTE: Large shelf can hold up to 25 lbs.

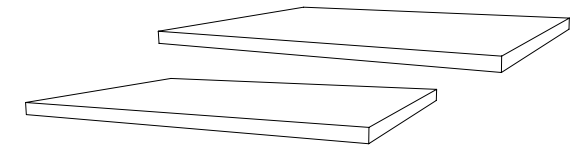

PLT-SMSHELF-BLK PLT-SMSHELF-GRY PLT-SMSHELF-WHT

Additional Shelving Set: Small Shelves – \$300 LIST

Includes two small shelves that are available in three different laminates: White, Gray, and Black.

NOTE: Small shelf can hold up to 25 lbs.

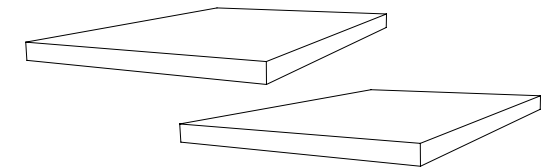

* Cantilever means the accessory is braced in two or more points, giving the illusion that the accessory is floating and has no visible hardware.

Example of Ordering Pallet and Pallet Accessories

All Accessory item numbers must also be placed on the order as a separate line item.

EXAMPLE OF PALLET ORDER

PLT2 POM WHT LE
Style and Size Species Finish Laminate Door Pull Electric

Example of Pallet Accessories:

PLT-WHITEBD..... 1 Whiteboard
PLT-HOOK..... 2 Pallet Hooks
PLT-CUBBY..... 1 Pallet Cubby

WARRANTY INFORMATION

Limited Lifetime Warranty:

Waddell warrants all cases to be free from defects in material and workmanship under normal use and care. Our warranty covers replacement of parts and material only. Electrical fixtures are covered for one year. Contact Waddell Customer Service for all warranty claims and replacements.

Finish Warranty:

Minor variations in finish color may occur due to the unique texture and grain of wood. Warranty does not cover finish damage under normal wear and tear.

Exclusions:

This warranty does not apply to:

- Damage caused by drilling or mounting customer's own materials to case without following Waddell's installation instructions
- Normal wear and tear, which is to be expected during the period of ownership
- Color, grain, or texture of wood, laminate, and other covering materials
- Non-compliance with installation and maintenance instructions
- Damages or failures resulting from modifications, alterations, misuse, abuse, negligence, or improper care and maintenance of our products

Follow these procedures to process warranty issues:

1. Contact Waddell Customer Service (800.622.1331) and provide the purchase order number or acknowledgment number if available, and a detailed description of the warranty issue.
2. Customer Service will determine and pre-approve all resolutions to the claim such as replacement units, service parts, labor and repair charges. Upon approval, resolutions will be assigned an authorization number.
3. The authorization number must be included on all invoices for reimbursement. Any unauthorized charges will not be the responsibility of Waddell.

